

Series 806 Mil-Aero Connectors



Crimp Tools, Positioners, Hex Dies and Insertion/Extraction Tools

CRIMP TOOL FOR #20HD, AND #22HD CONTACTS PLUS CENTER PIN #16, #12, AND #8 RF CONTACTS



809-015 (M22520/2-01) crimper for use with size #20HD and #22HD signal contacts and #8, #12, #16 co-axial and tri-axial Series 806 contacts. Requires positioner, sold separately. These crimp tools perform precision eight indent crimps for wire terminations and excellent tensile strength. Adjustment wheel has 8 settings. Ratchet mechanism prevents improper crimps. Use with bayonet-type positioners. Length is 6.75 inches, weight is approx. 10 oz.

Contact Type	Ref. Contact Part Number		Positioner	
	Pin	Socket	Pin	Socket
#22HD Contact	850-094-1	850-095-1	859-147	809-005
#22HD, Small Dia. Wire	850-094-2	850-095-2	859-148	809-057
#20HD Contact	809-204	809-205	809-206	809-206
#16 Coaxial Inner Contact*	809-114 and 809-115	809-116 and 809-117	809-125 (M22520/2-35)	
#8 Diff. Twinax Inner Contact*	853-076	853-075	M22520/2-37	
#8 Quadrax Inner Contact*	854-047	854-048	M22520/2-37	
#8 Twinax Inner Contact*	854-047	854-048	M22520/2-37	

* Requires outer contact crimp tooling as well, refer to tools below and on following page.

CRIMP TOOL FOR SIZE #12, 3 GHZ COAX CENTER PIN



809-128 special crimper with sharper indenter tips for use with size #12 Series 806, 3 GHz coax center pin. Requires positioner, sold separately. These crimp tools perform precision eight indent crimps for wire terminations and excellent tensile strength. Ratchet mechanism prevents improper crimps. Use with bayonet-type positioners. Length is 6.75 inches, weight is 10 oz.

Contact Description	Ref. Contact Part Number		Positioner
	Pin	Socket	
#12, 3GHz Coaxial Inner Contact	852-016-01, 02, 03	852-015-01, 02, 03	859-006

* Requires outer contact crimp tooling as well, refer to tools below and on following page.

CRIMP TOOL FOR SIZE #12, AND #16 POWER CONTACTS



809-136 (M22520/1-01) crimper for use with size #12, and #16 Series 806 contacts. Requires positioner, sold separately. These crimp tools perform precision eight indent crimps for wire terminations and excellent tensile strength. Adjustment wheel has 8 settings for wire being used. Ratchet mechanism prevents improper crimps. Use with bayonet-type positioners. Length is 9.75 inches, weight is 15 oz.

Contact Description	Ref. Contact Part Number		Positioner
	Pin	Socket	
#16 Contact	809-110	809-111	809-137 (M22520/1-04)
#12 Contact	809-112	809-113	809-137 (M22520/1-04)

Series 806 Mil-Aero Connectors



Crimp Tools, Positioners, Hex Dies and Insertion/Extraction Tools

CRIMP TOOL AND POSITIONER FOR SIZE #16 COAX SHIELD CRIMP SLEEVE



809-127 (M22520/4-01) crimper for use with size #16 coax Series 806 contacts. Requires positioner, ordered separately. These crimp tools perform precision eight indent crimps for wire terminations and excellent tensile strength. Ratchet mechanism prevents improper crimps. Use with bayonet-type positioners. Length is 9.75 inches, weight is 15 oz.

Contact Description	Ref. Contact Part Number		Positioner
	Pin	Socket	
#16 Coaxial Contact	809-114 and 809-115	809-116 and 809-117	809-126 (M22520/4-02)

CRIMP TOOL FOR SIZE #12 COAX SHIELD CRIMP SLEEVE



809-133 (M22520/31-01) crimper for use with size #12 Series 806 coax contacts. Requires positioner, ordered separately. These crimp tools perform precision eight indent crimps for wire terminations and excellent tensile strength. Adjustment wheel has 8 settings for wire being used. Ratchet mechanism prevents improper crimps. Use with bayonet-type positioners. Length is 9.75 inches, weight is 15 oz.

Contact Description	Ref. Contact Part Number		Die Set
	Pin	Socket	
#12 Coaxial Outer Contact	809-118 and 809-119	809-120 and 809-121	809-134 (M22520/31-02)

CRIMP TOOL FOR SIZE #8 TWINAX AND QUADRAX SHIELD CRIMP SLEEVE



Standard 809-129 (M22520/5-01) crimper. Use with size #8 twinax and quadrax Series 806 RF contacts. Requires hex-die, ordered separately. These crimp tools attach contact body to cable. Length is 11 inches, weight is approx. 1.476 lbs. For use with interchangeable coax hex-dies. Dies snap in frame of M22520/5-01 and are held in frame by internal spring clips.

Contact Description	Ref. Contact Part Number		Die Set
	Pin	Socket	
#12, 3GHz Coaxial, Outer Contact	852-016-01, -02	852-015-01, -02	809-130 (M22520/5-03) Hex Die
#12, 3GHz Coaxial, Outer Contact	852-016-03	822-015-03	809-130 (M22520/5-03) Hex Die
#8 Coaxial, Outer Contact	852-149-01, -02	852-148-01, -02	M22520/5-03 Hex Die
#8 Diff. Twinax	853-076	853-075	M22520/5-45
Quadrax	854-047	854-048	M22520/5-45

Series 806 Mil-Aero Connectors

Crimp Tools, Positioners, Hex Dies and Insertion/Extraction Tools

PNEUMATIC CRIMP TOOL FOR #8 POWER CONTACTS

The Daniels WA23 pneumatic crimp tool sets the standard for heavy duty crimping chores. This four-indent tool accommodates large power contacts ranging from size 8 through size 0000. Die plates and locators are purchased separately. Qualified to M22520/23, the WA23 tool is specified for use with SAE AS39029 closed barrel copper alloy contacts.

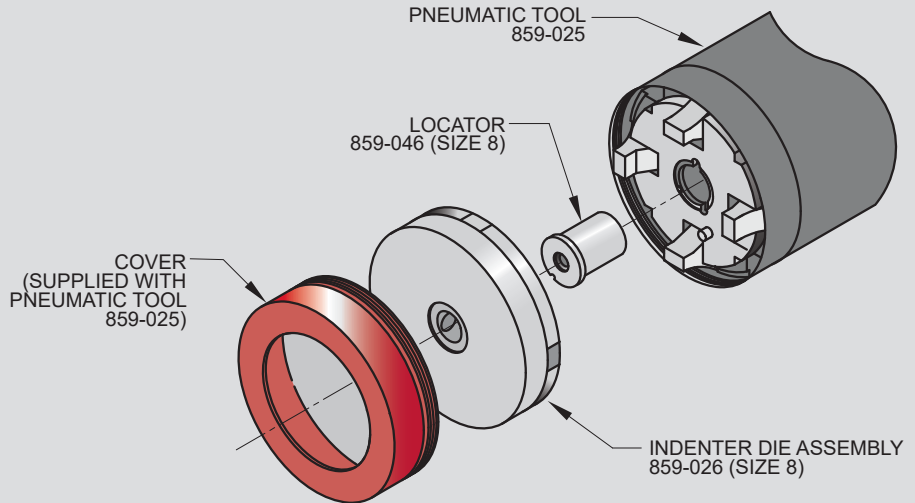

PNEUMATIC CRIMP TOOL



Bench mount heavy duty pneumatic indent crimp tool. Four-indent crimp termination. Use with closed barrel contact sizes 8 through 4/0. Attach to air supply with quick-disconnect fitting or install 1/4 NPT fitting into tapped port. 90-120 psi air supply. Requires die assembly and locator, sold separately. Hand actuate with push-button valve trigger on handle. Steel with black wrinkle enamel coating. 13 inches overall length, 9.2 inches tall, 17 pounds (7.7 Kg).

Description	Part Number	Military Part Number	Daniels Part Number
Pneumatic Crimper	859-025	M22520/23-01	WA23

DIE ASSEMBLY FOR SIZE #8 CONTACTS



Indenter Die Assembly. Precision four-indent die with hardened tool steel indenters, stainless steel housing, aluminum cap. Use with size #8 contacts. Go/ No Go calibration dimensions are stamped on face of tool. Approximately 3.3 inches (84mm.) diameter.

Description	Part Number	Military Part Number	Daniels Part Number
Die Assembly, Size #8	859-026	M22520/23-02	WA23-2

LOCATOR FOR SIZE #8 CONTACTS



Aluminum locator holds contact at correct depth for crimping.

Description	Part Number	Military Part Number	Daniels Part Number
Locator, #8, Special	859-046	(none)	WA23-395L
Locator, #8, Spring Loaded	859-164	(none)	WA23-395SSL

Series 806 Mil-Aero Connectors



Crimp Tools, Positioners, Hex Dies and Insertion/Extraction Tools

INSERTION/EXTRACTION TOOL FOR #20HD CONTACTS

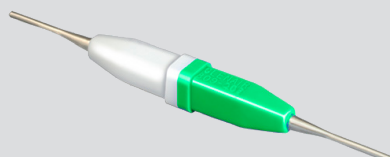

Insertion/Extraction Tool for #20HD Contacts. This tool features molded plastic grips and sturdy stainless steel or thermoplastic tips.

Contact Size	Tip Material	Color	Insertion/Extraction Tool
#20HD	Stainless Steel	Green (Ins.)/White (Ext.)	809-203
#20HD	Thermoplastic	Green (Ins.)/Blue (Ext.)	809-203D*

* Append D for Delrin tip

INSERTION/EXTRACTION TOOLS FOR #22HD CONTACTS

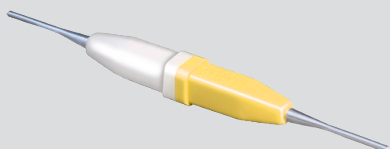

Insertion/extraction tool for #22HD contacts. Features molded plastic grips and sturdy stainless steel tips. White/yellow molded handle.

Contact Size	Tip Material	Color	Insertion/Extraction Tool
#22HD	Stainless Steel	Yellow (Ins.)/White (Ext.)	859-163 <i>(M81969/1-05)</i>

INSERTION/EXTRACTION TOOLS FOR #16 POWER CONTACTS

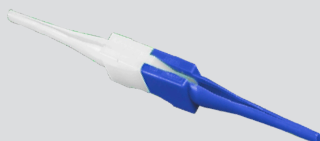

Insertion/Extraction Tool for #16 contacts. For use with power contacts. Economical molded plastic. White extraction tip, blue insertion tip.

Contact Size	Material	Color	Insertion/Extraction Tool
#16	Delrin or Equivalent	Blue (Ins.)/White (Ext.)	809-131 <i>(M81969/14-03)</i>

INSERTION/EXTRACTION TOOLS FOR #16, COAX CONTACTS



Insertion/Extraction reverse tweezer for #16 shielded coax contacts. Metal construction.

Contact Size	Material	Color	Insertion/Extraction Tool
#16	Stainless Steel	Blue Tipped Handle	<i>(M81969/8-08)</i>

Series 806 Mil-Aero Connectors



Crimp Tools, Positioners, Hex Dies and Insertion/Extraction Tools

INSERTION/EXTRACTION TOOLS FOR #12, POWER CONTACTS

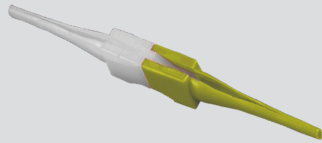

Insertion/Extraction tool for #12 power contacts.

Contact Size	Material	Color	Insertion / Extraction Tool
#12	Thermoplastic	Yellow (Ins.)/White (Ext.)	809-132 (M81969/14-04)

INSERTION/EXTRACTION TOOLS FOR #12, 50 AND 75 COAX CONTACTS



Insertion/Extraction reverse tweezer for #12 power contacts. Metal construction. Yellow tip handle

Contact Size	Material	Color	Insertion Tool	Extraction Tool
#12	Stainless Steel	Yellow Tipped Handle	(M81969/8-09)	(M81969/8-10)

INSERTION/EXTRACTION TOOLS FOR #12, 50 OHM MATCHED IMPEDANCE 3 GHZ COAX CONTACTS



Insertion/Extraction reverse tweezer for #12 power contacts. Metal construction. Blue tip handle

Contact Size	Material	Color	Insertion / Extraction Tool
#12	Stainless Steel	Blue (Ins.)/White (Ext.)	(M81969/8-07)

INSERTION/EXTRACTION TOOLS FOR #12, 75 OHM MATHCHED IMPEDANCE 3 GHZ COAX CONTACTS

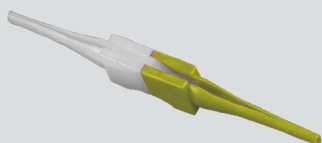

Insertion/Extraction tool for #12 power contacts. Metal construction. Yellow tip handle

Contact Size	Material	Color	Insertion / Extraction Tool
#12	Thermoplastic	Yellow (Ins.)/White (Ext.)	809-132 (M81969/14-04)

ENVIRONMENTAL, MICRO MINIATURE CIRCULAR Series 806 Mil-Aero Connectors



Crimp Tools, Positioners, Hex Dies and Insertion/Extraction Tools

HOW TO TERMINATE, INSTALL AND REMOVE SIZE #22 CONTACTS

1 Set Up Crimp Tool. Install proper positioner into crimp tool. The label on the positioner shows the proper tool setting for each wire size. Turn the adjustment wheel to the correct setting.

2 Strip Wire. Remove wire insulation, taking care to avoid nicking or cutting wire strands. Strip wire to length shown.

3 Insert wire into contact. The wire should be visible in the inspection hole.

4 Insert contact into crimp tool as shown. Make sure that the contact is fully inserted into the tool. Squeeze handle completely. The ratchet mechanism will not allow a partial crimp. Release handle and remove contact.

5 Inspect crimped contact. Wire should be fully inserted and the crimp should be uniform in appearance.

Insertion/Extraction Tool 859-163

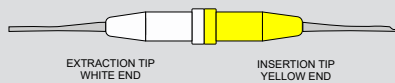

6 Install contact into connector. Push the contact through the rear grommet until the contact locks into place. This can usually be done by hand without the need for a tool. If the wire gage is #26 or smaller, a tool is helpful. There are two techniques for installing contacts with a tool. One method is to push the contact in by hand, then use the tool to finish the insertion. The other method is to position the insertion tip against the contact shoulder, then insert the contact. Use insertion/extraction tool 859-163 to install contacts. Slide the wire into the groove on the yellow end of the tool. Slide the tool tip up the contact until it touches the contact shoulder. **USE CARE TO AVOID DAMAGING THE CONNECTOR.**

7 Contact Extraction. Use tool 859-163. The white end is used for contact extraction. First, push the wire into the groove of the metal tip. Slide the tip of the tool into the connector. Push the tool into the connector cavity until the tip bottoms in the connector. Avoid wiggling or rocking the tip. This may damage the cavity. A straight push is best. Pinch the wire between your finger and the white plastic grip and slide the tool and contact out of the connector. **Wire insulation diameter greater than 0.045 inches (1.14mm) is too large to work properly with the extraction tool. connector damage is possible.**

